



## Care and Maintenance

**CAUTION:** To avoid damaging the product, never immerse the product in water or other liquids.

Do not use abrasive cleaners on the product. Dust with a soft cloth using extreme caution around the blade.



# Plastic Paper Guillotine

Operating Instructions







**BEFORE USING THIS PRODUCT, READ, UNDERSTAND, AND FOLLOW THESE INSTRUCTIONS.**

**FOR INDOOR USE ONLY**

## IMPORTANT SAFEGUARDS

- **Read all instructions before using.**
- This product is not intended for use by children. Keep product out of the reach of children and pets.
- This product is intended for use in trimming paper. Do not use the product for any other purpose.
- Keep loose items (e.g., hands, fingers, jewelry, clothing, neckties, etc.) away from the blade to avoid personal injury or damage to the product.
-  To avoid damage to the product
  - Remove paper clips and staples from items before trimming paper.
  - Never lubricate the cutting blade.
  - Do not expose product to water or other liquids.
-  To avoid possible severe personal injury
  - Never operate the trimmer without the safety shield in place
  - Never carry the trimmer by the blade.
  - Never carry the trimmer by the cutting handle.
  - Always ensure the blade lock is secure when the product is not in use.
- Do not attempt to dislodge jammed debris with a pointed object, as personal injury or product damage may occur.
- Always operate the product on a flat, level, steady surface to avoid it overturning.
- Do not hang or wall-mount the product.
- This product is intended for indoor use only. Do not use outdoors.

**SAVE THESE INSTRUCTIONS FOR FUTURE REFERENCE**

## Components description

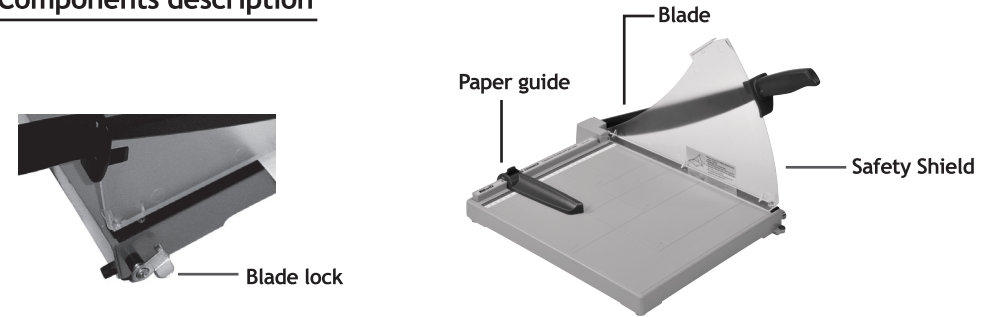

## Performance

Specification	A4	B4	A3
Base size (W x D) in mm	305x350	360x425	360x480
Cutting length(mm)	335	385	440
Cutting capacity sheets(80 gsm)	10	10	10
Clamp	press	press	press
Safety shield	ABS shield	ABS shield	ABS shield
Blade lock	✓	✓	✓
Measuring scale	MM/INCH	MM/INCH	MM/INCH
Format Indication	A6-A4	A6-B4	A6-A3

## How to use

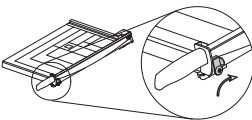
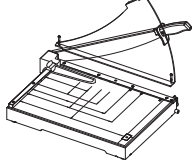
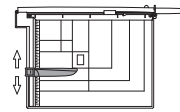
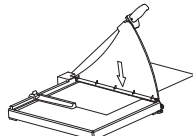
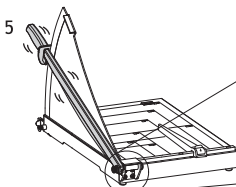
1. Hold the handle and release the blade lock carefully. 
2. Raise up the handle to screw in safety shield firmly. 
3. Adjust the paper guide to proper position. 
4. Push down the safety shield to hold the paper firmly when cutting. 
5. For hundred times cutting, the handle is loose and easy to drop down once raising the handle upto the top. 
6. Take out the plastic cap and use hexagon wrench to tighten the screw both side and return it as well. 